

For construction with wall studs on 16 in. centers, the header is located between the studs for the right side mounting. For construction with wall studs on centers greater than 19-1/2 in. provide secure header as shown.

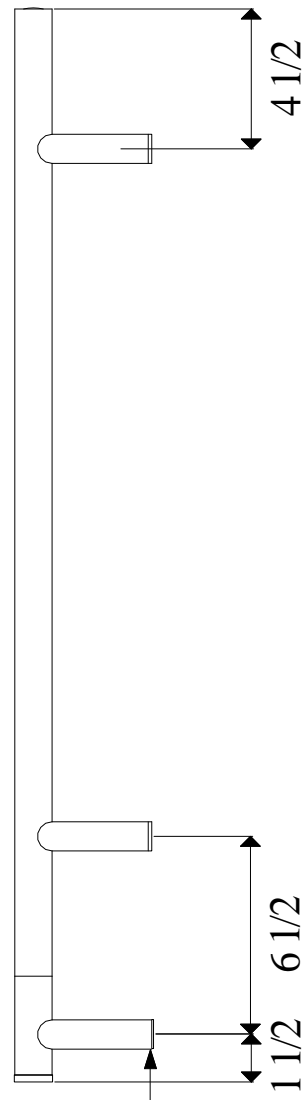

Wire cover tube fits into centre of cover plate which fits over single gang box

JEEVES MODEL C STRAIGHT

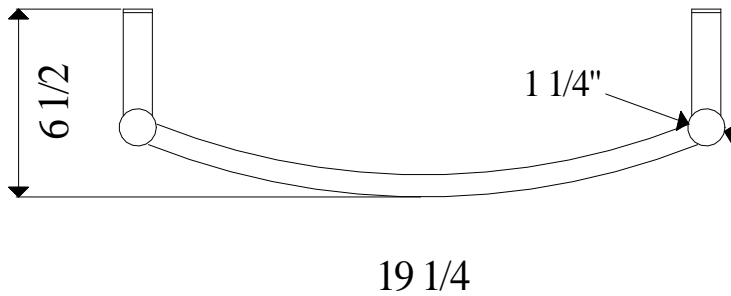

For construction with wall studs on 16 in. centers, the header is located between the studs for the right side mounting. For construction with wall studs on centers greater than 19-1/2 in. provide secure header as shown.

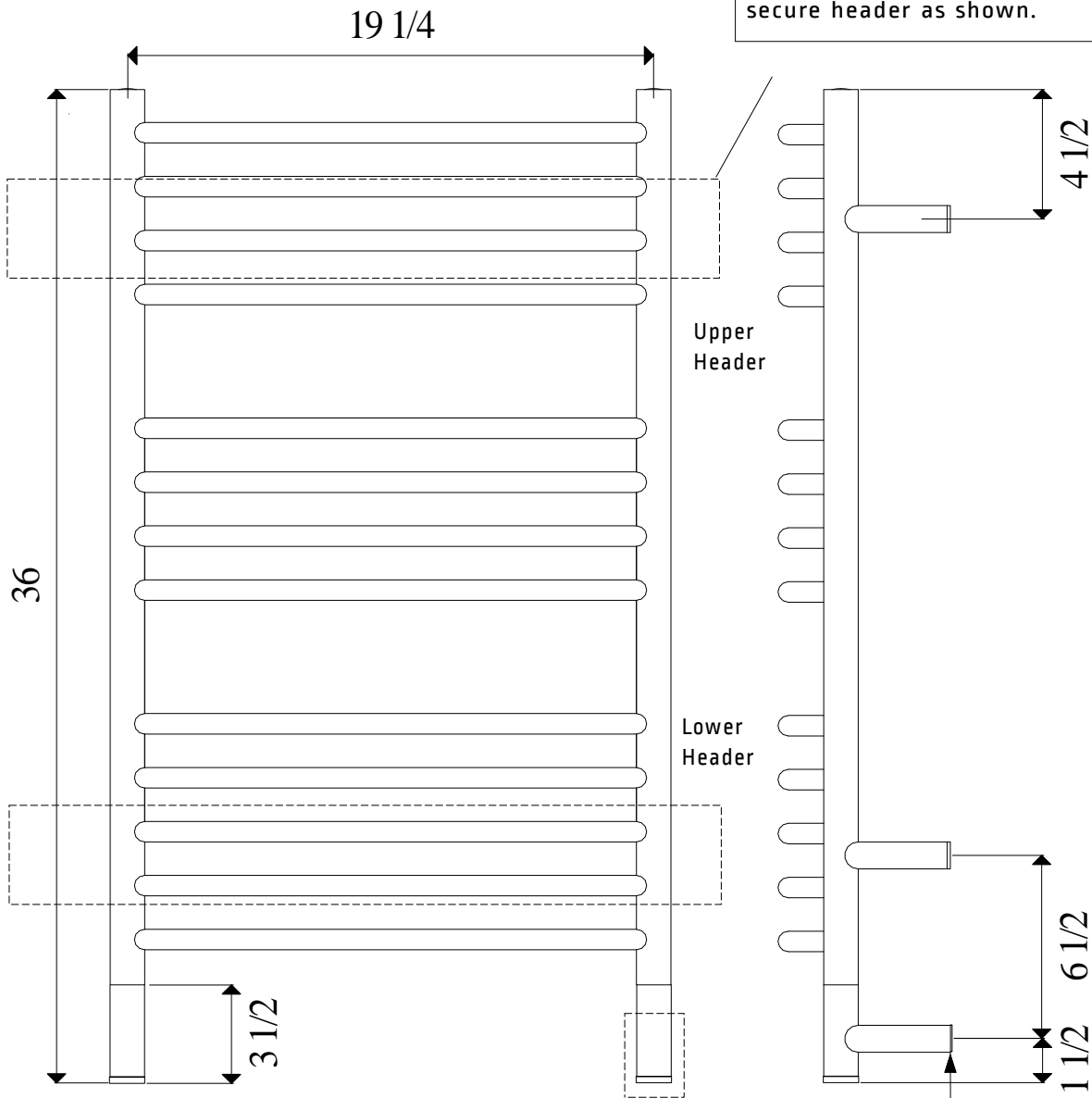

Wire cover tube fits into centre of cover plate which fits over single gang box

JEEVES

MODEL C CURVED

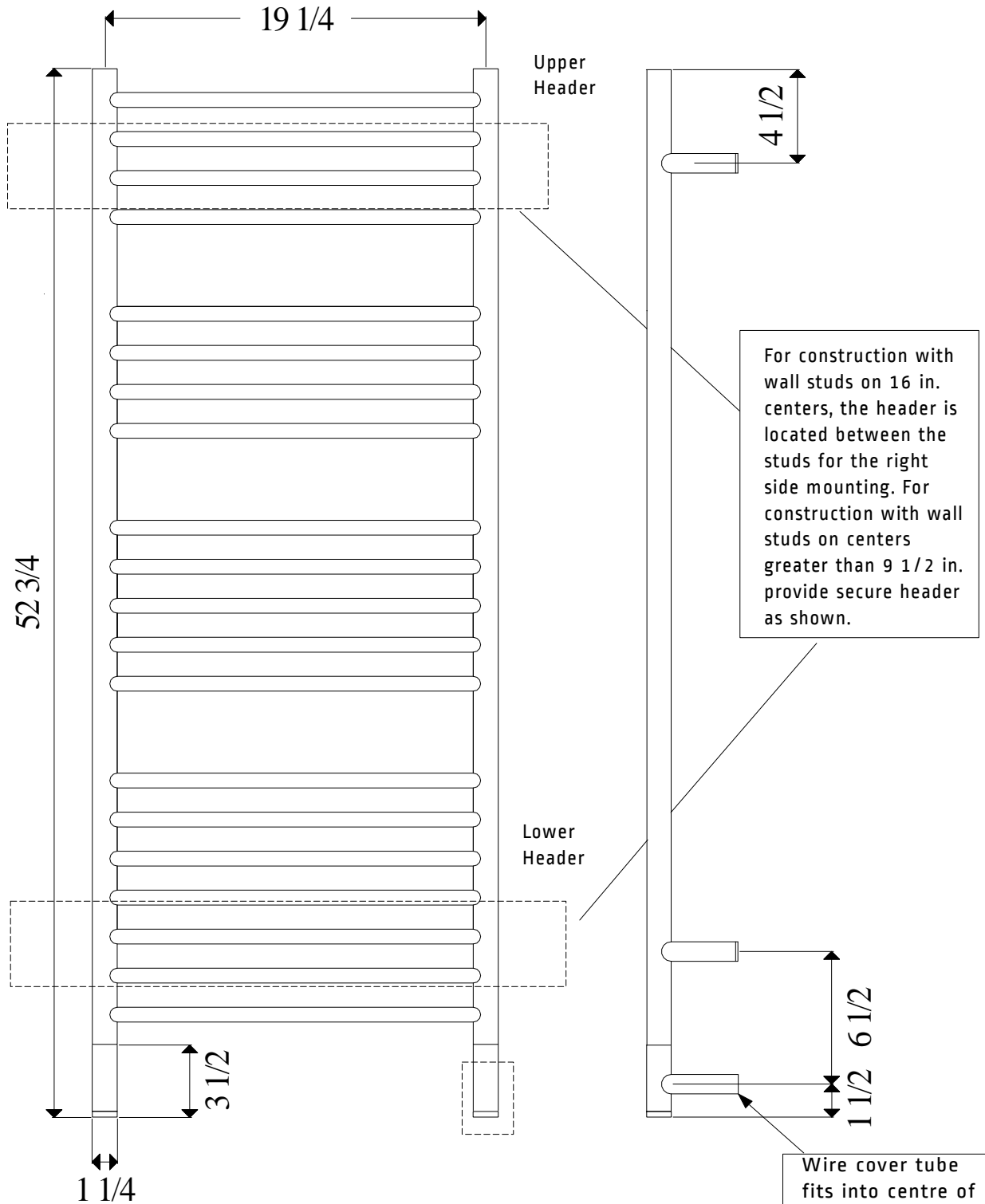

JEEVES MODEL D STRAIGHT

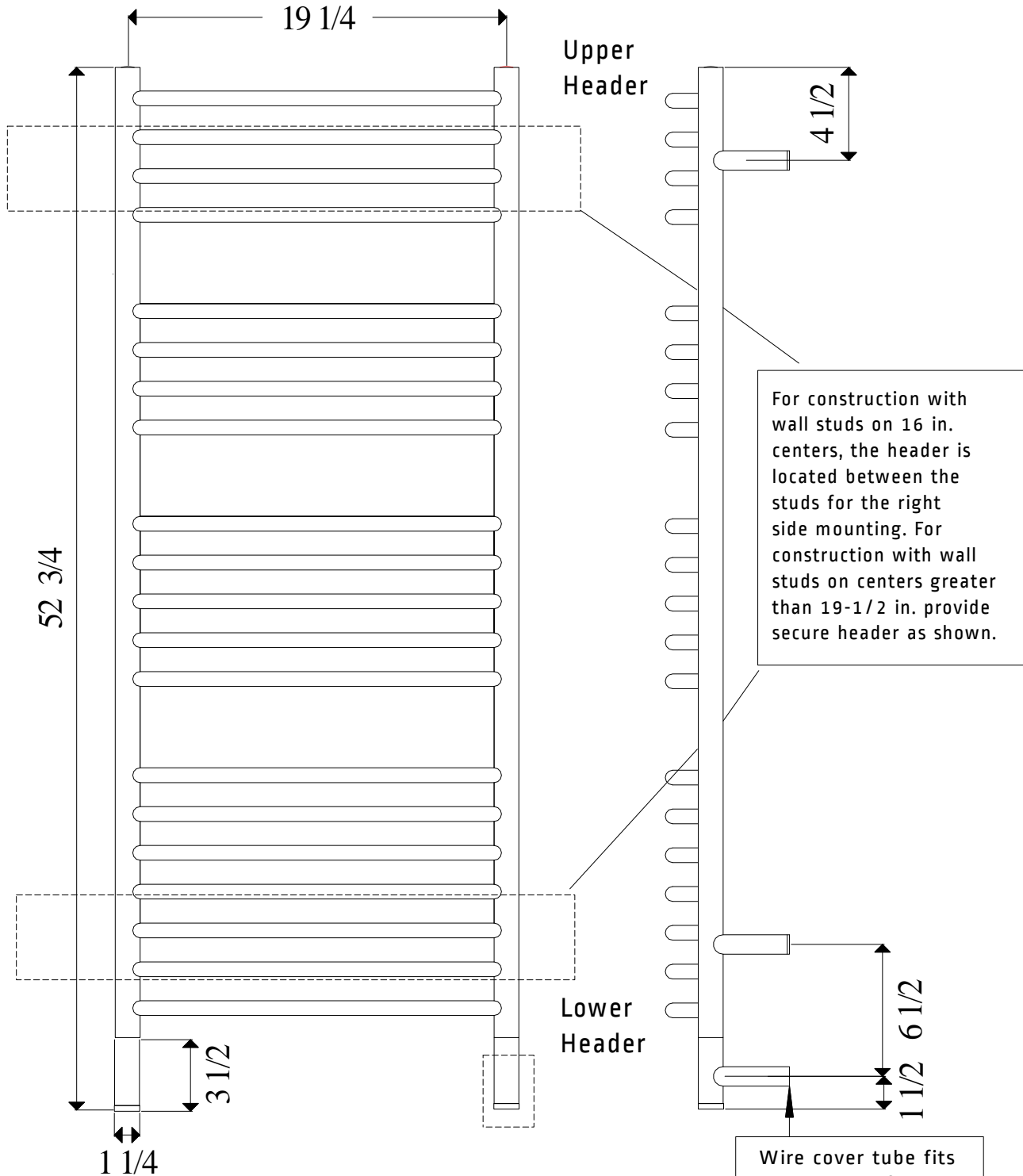

JEEVES

MODEL D CURVED

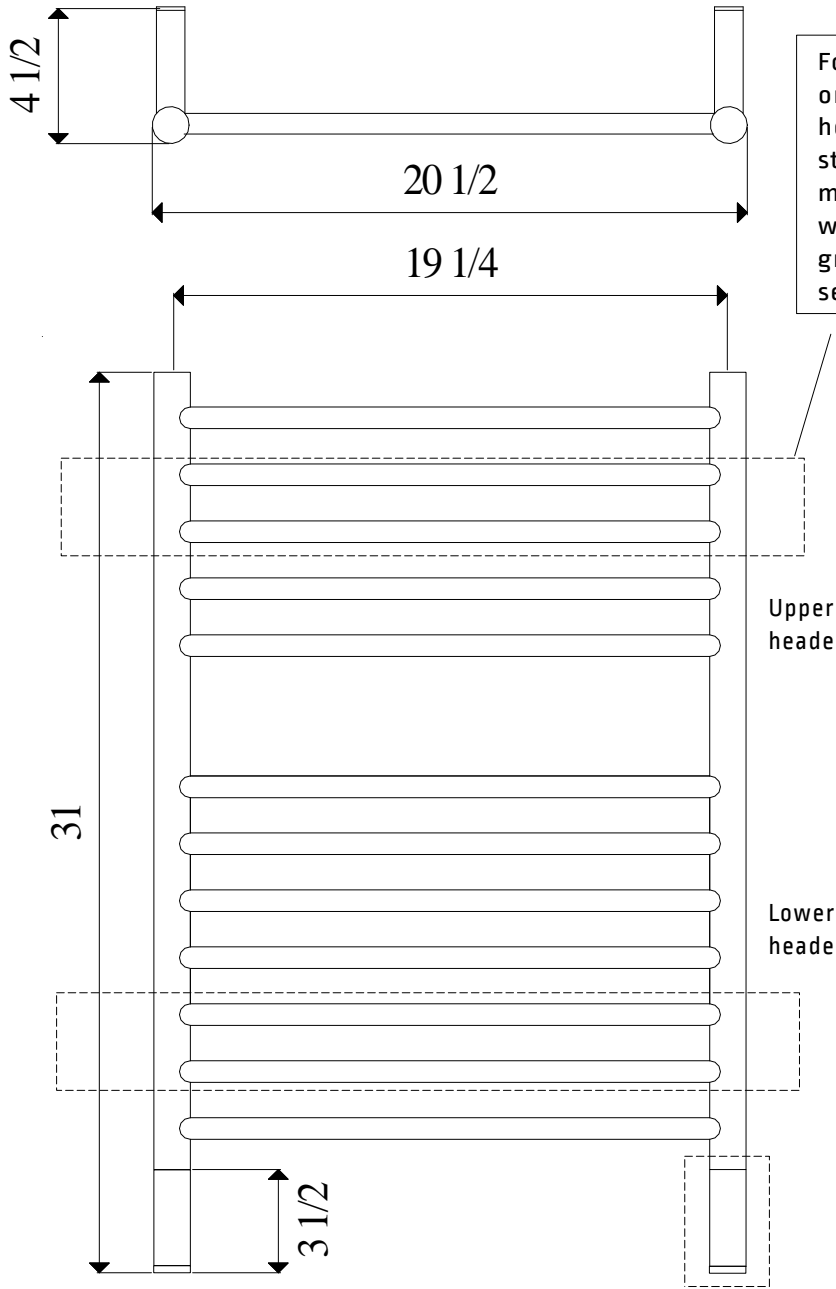

For construction with wall studs on 16 in. centers, the header is located between the studs for the right side mounting. For construction with wall studs on centers greater than 19-1/2 in. provide secure header as shown.

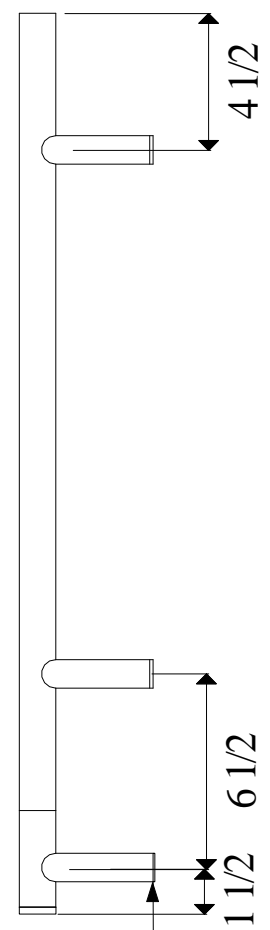

Wire cover tube fits into centre of cover plate which fits over single gang box

JEEVES MODEL E STRAIGHT

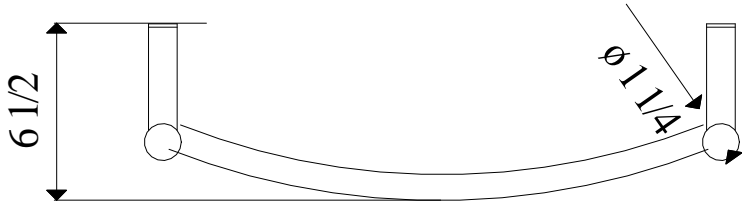

For construction with wall studs on 16 in. centers, the header is located between the studs for the right side mounting. For construction with wall studs on centers greater than 19-1/2 in. provide secure header as shown.

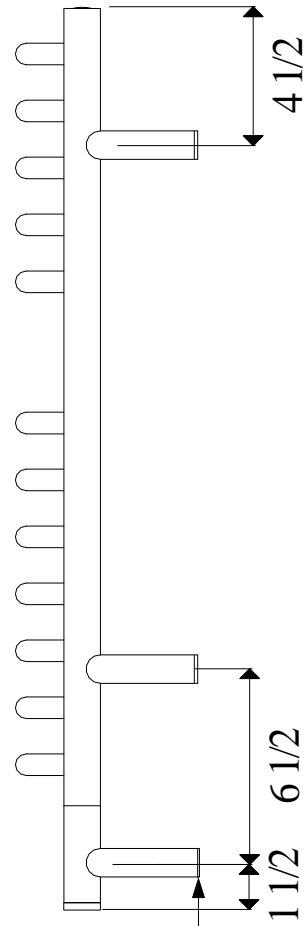
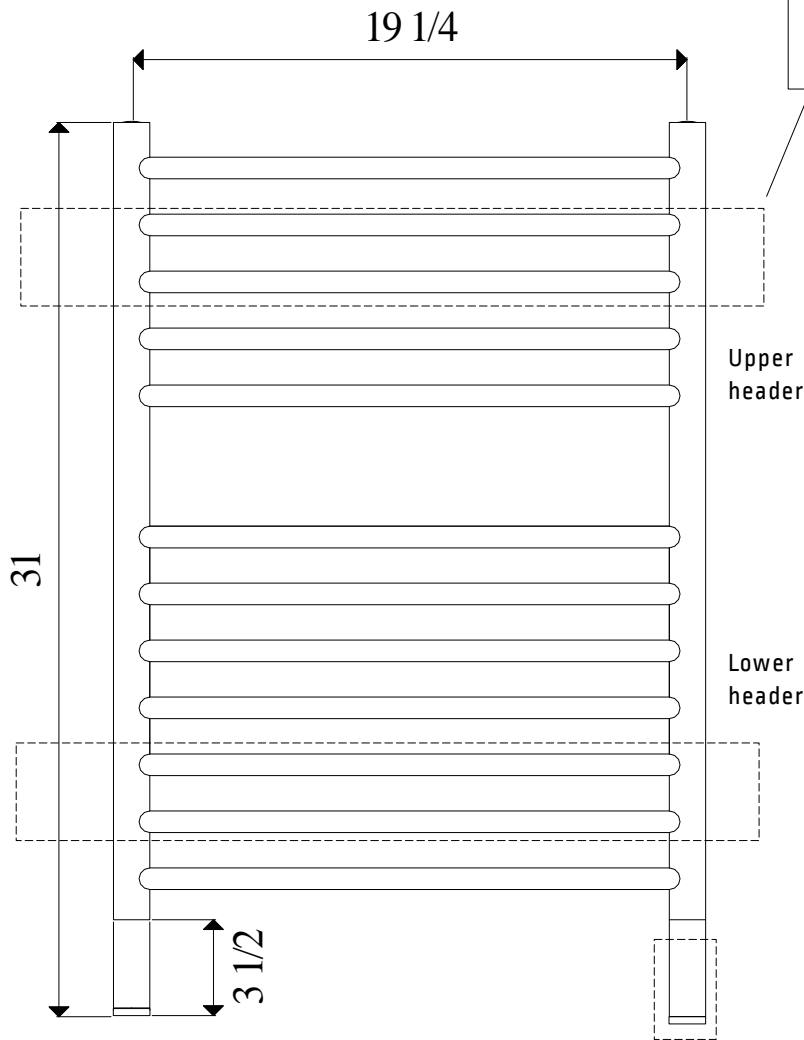

Wire cover tube fits into centre of cover plate which fits over single gang box

JEEVES

MODEL E CURVED

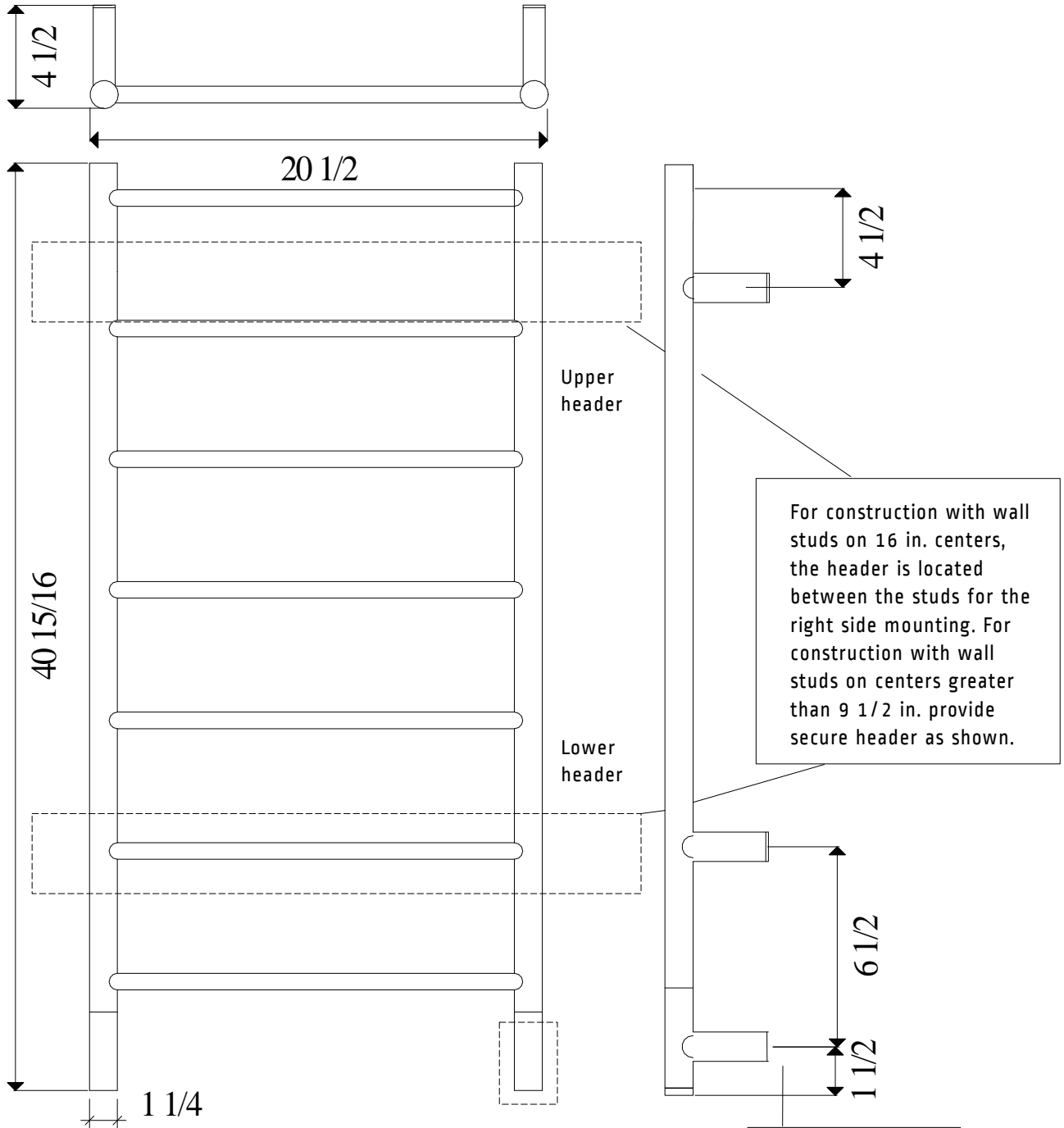

JEEVES MODEL F STRAIGHT

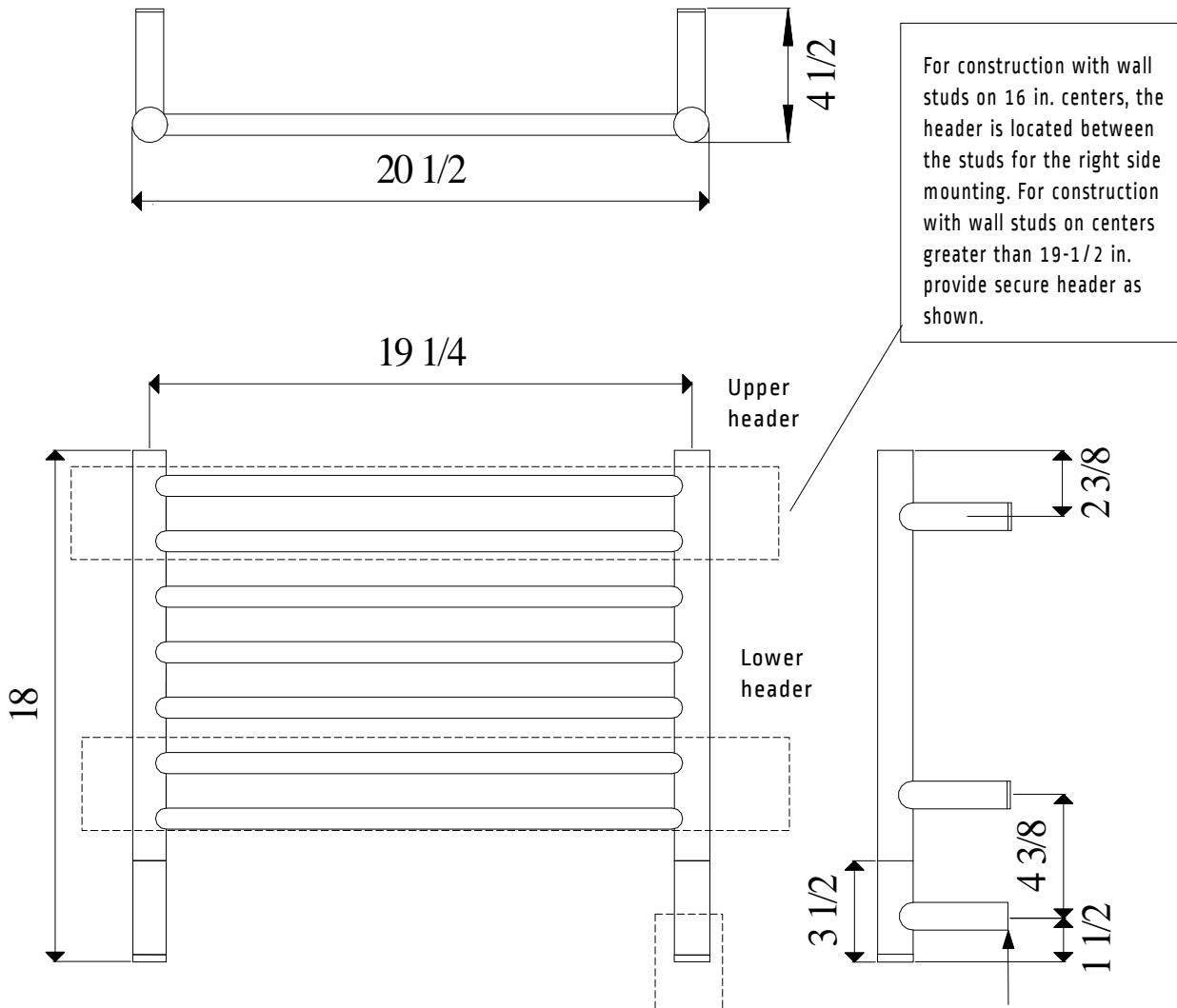

Wire cover tube fits into centre of cover plate which fits over single gang box

JEEVES MODEL H STRAIGHT

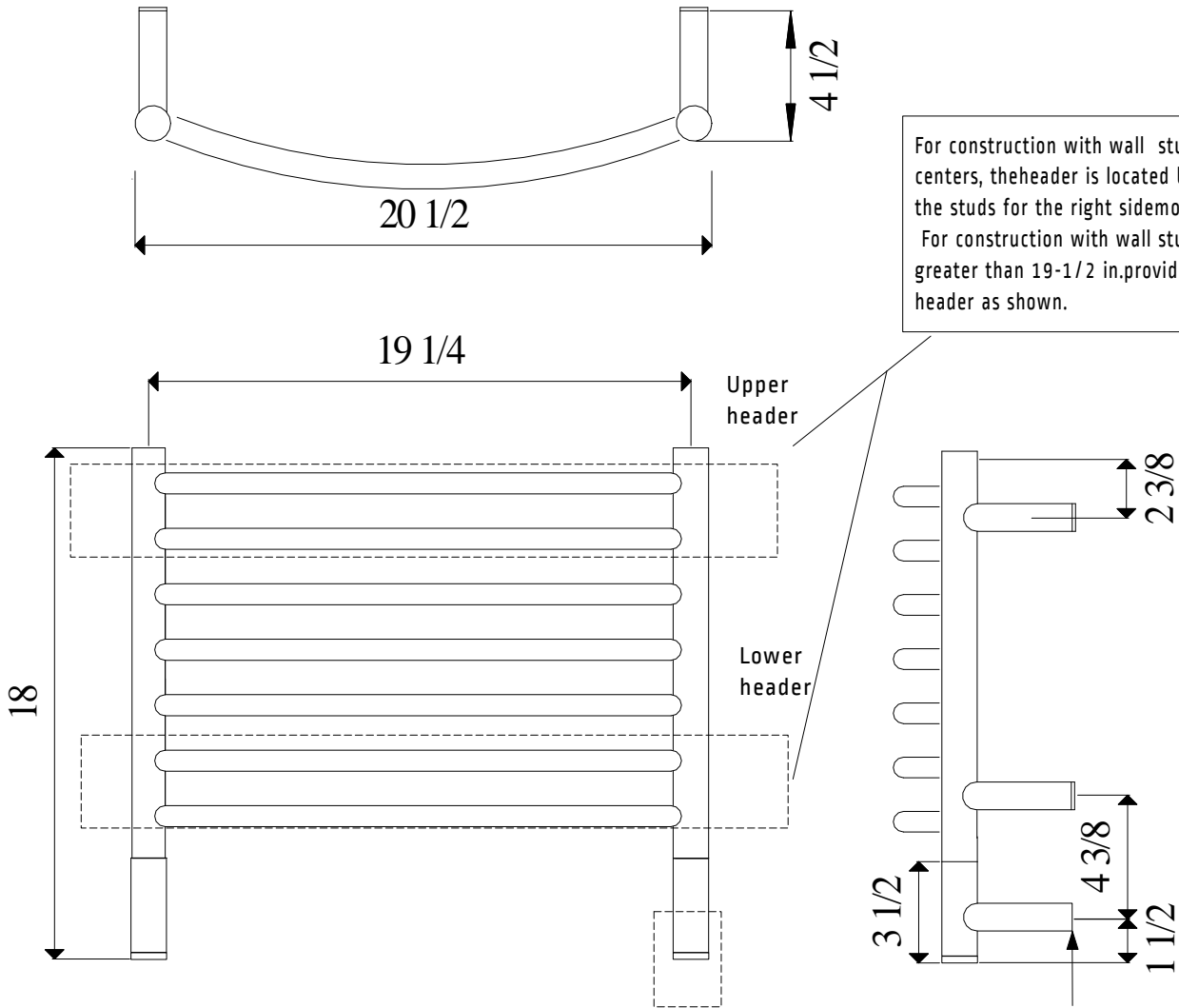

For construction with wall studs on 16 in. centers, the header is located between the studs for the right sidemounting.
For construction with wall studs on centers greater than 19-1/2 in. provide secure header as shown.

Wire cover tube fits into centre of cover plate which fits over single gang box

JEEVES MODEL H CURVED

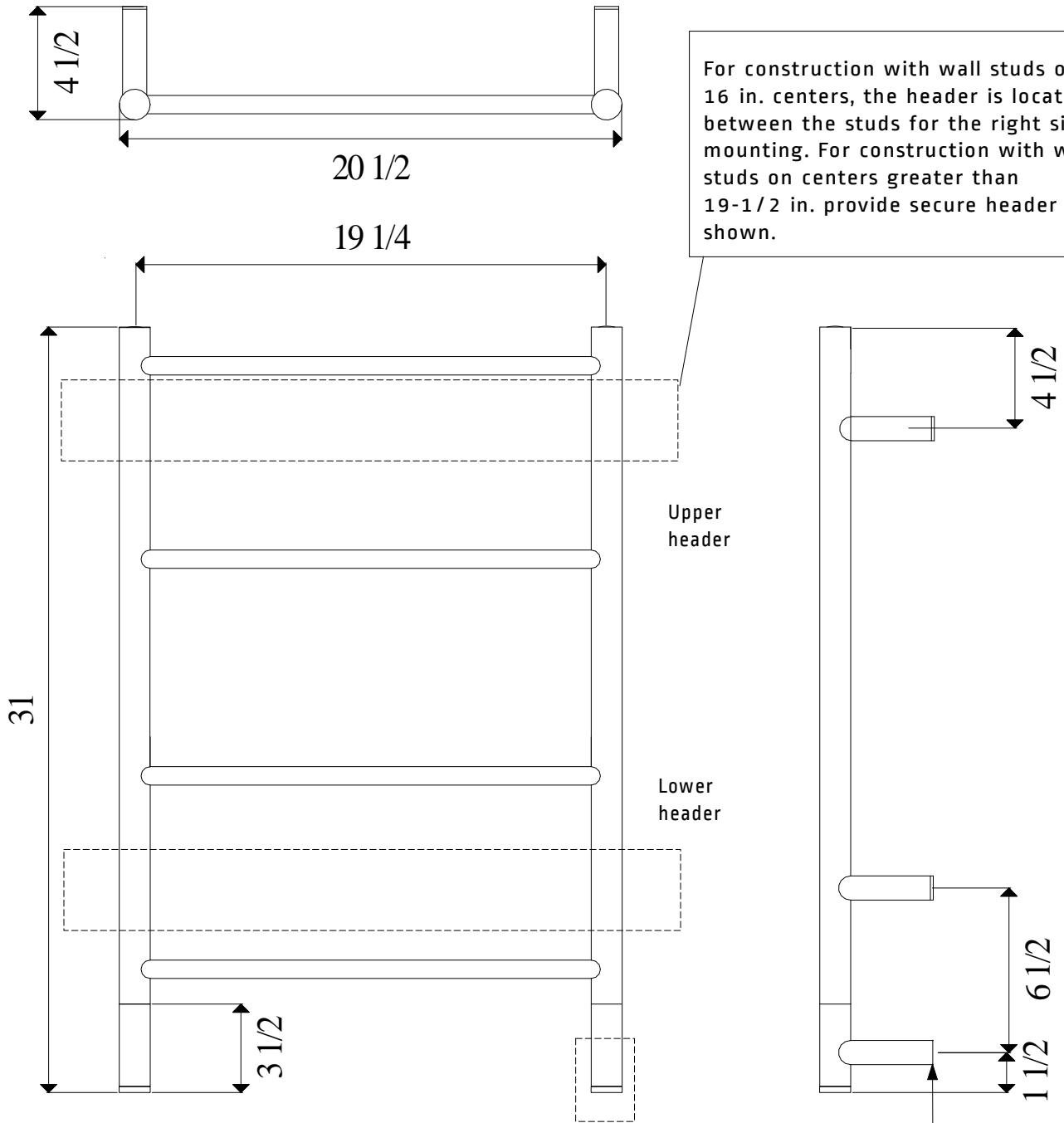

For construction with wall studs on 16 in. centers, the header is located between the studs for the right side mounting. For construction with wall studs on centers greater than 19-1/2 in. provide secure header as shown.

Wire cover tube fits into centre of cover plate which fits over single gang box

JEEVES MODEL I STRAIGHT

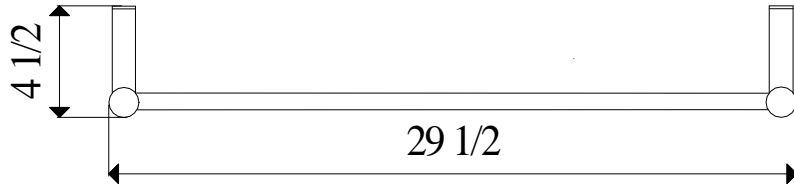

For construction with wall studs on 16 in. centers, the header is located between the studs for the right side mounting. For construction with wall studs on centers greater than $9 \frac{1}{2}$ in. provide secure header as shown.

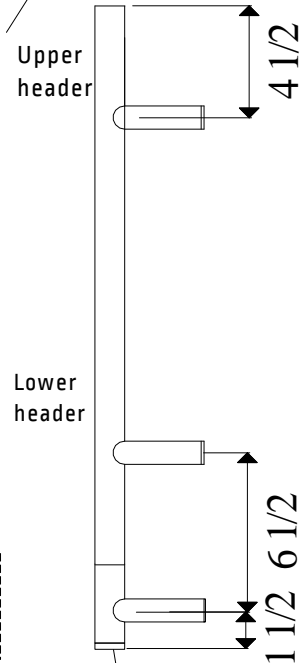
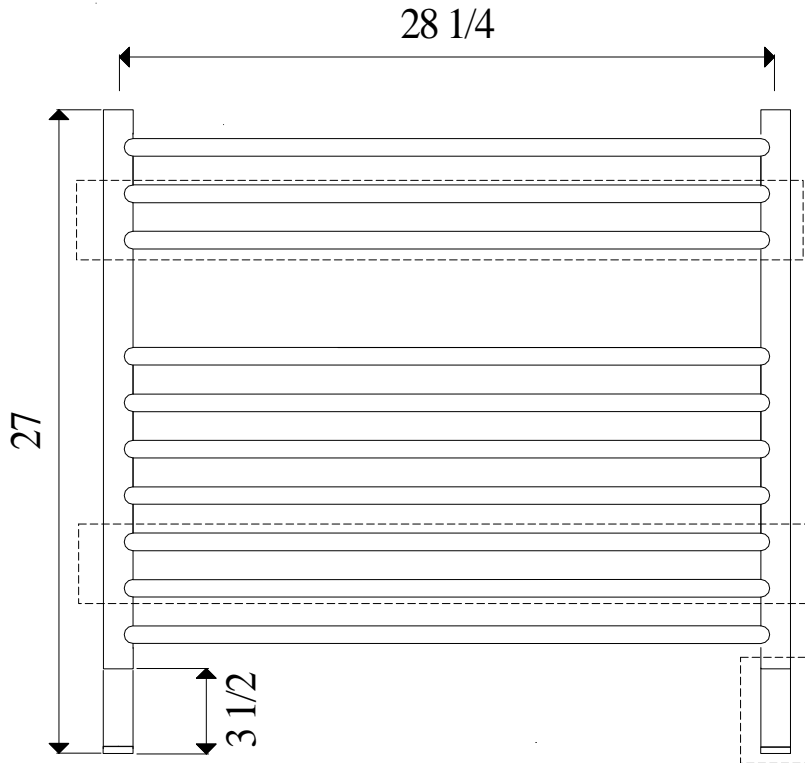

Wire cover tube fits into centre of cover plate which fits over single gang box

JEEVES MODEL K STRAIGHT

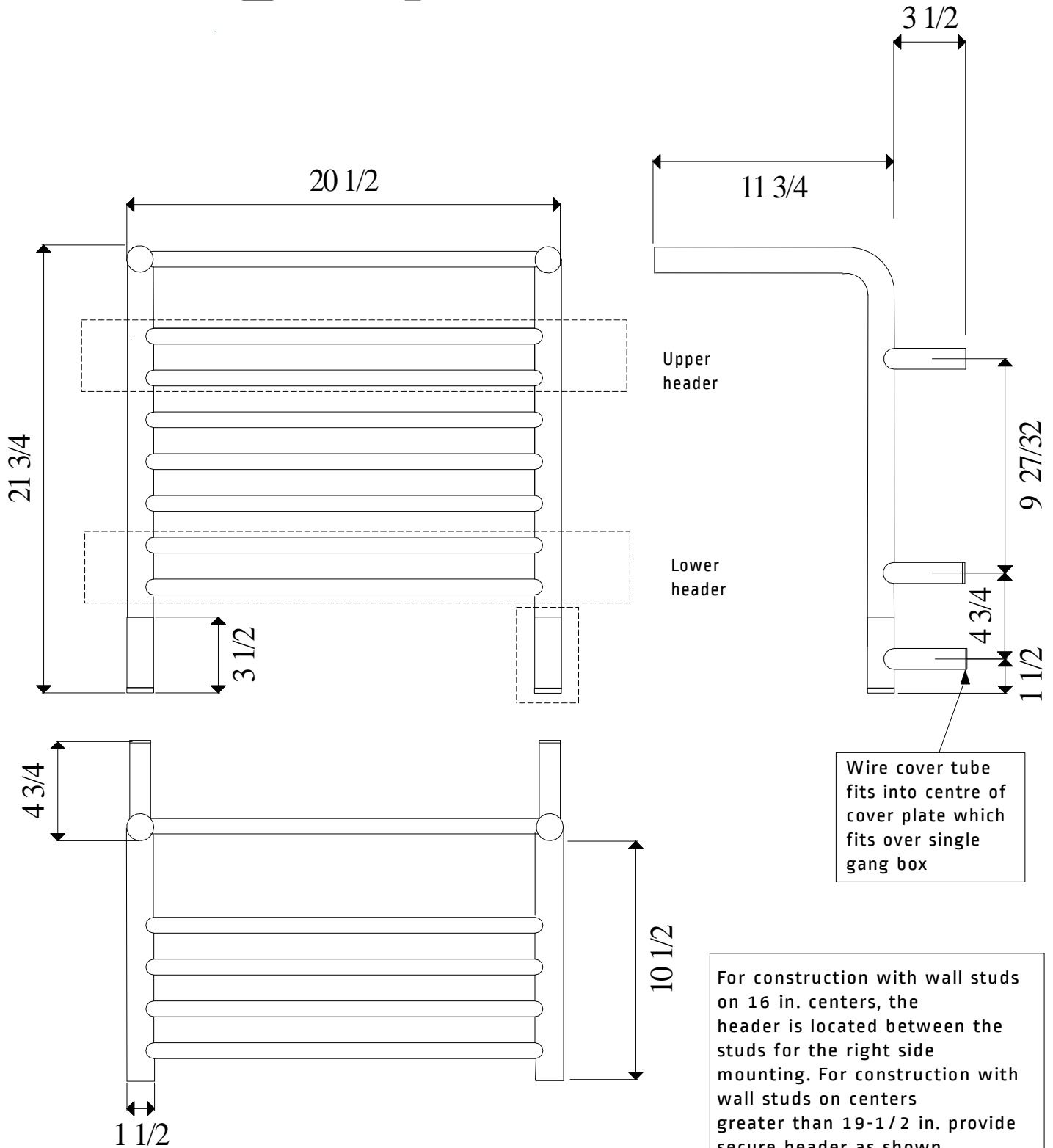

JEEVES MODEL M SHELF